



We produce level gauges to suit virtually any application, available in single or multi-sections, with a variety of shut-off valves, cocks and accessories. Basically there are two main types, described briefly as follows:-

REFLEX & TRANSPARENT LEVEL GAUGES

REFLEX Level Gauges

The Reflex Level Gauge, available in the range ANSI Class 150 to ANSI Class 1500, is particularly suitable for gas liquifaction plants, reactor vessels, low pressure boilers and storage vessels.

The Reflex Glass allows light to be absorbed in the liquid space giving a dark appearance and reflected in the gas space, thereby providing a clear indication of the liquid level.

- > Distinct black and silver indication.
- > Pressures up to ANSI Class 1500 (250 bar).
- > Temperature range -196°C to +400°C.

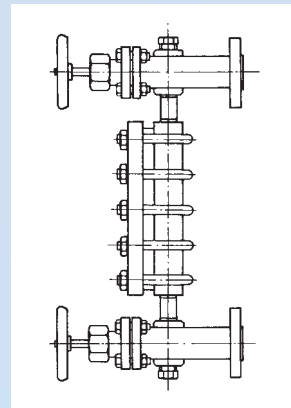

Standard REFLEX

Type R100

PN100
ANSI 600

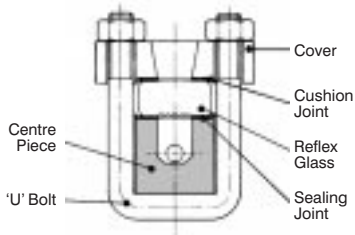

Weld-On

Type MWR

PN100
ANSI 600

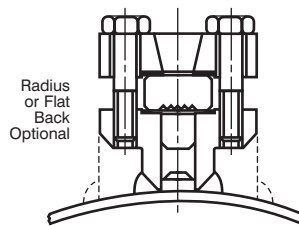

Reflex

Standard	Model	Rating
	R100	PN100, ANSI 600
	R160	PN160, ANSI 900
	R250	PN250, ANSI 1500
Weld-On	MWR	PN100, ANSI 600

TRANSPARENT Level Gauges

The Transparent Level Gauge, available in the range ANSI Class 150 to ANSI Class 1500, is particularly recommended for:-

1. Media which are corrosive to glass.
2. Viscous and coloured.
3. For interface applications.
4. Where additional lighting is required.
5. Can be illuminated.
6. Suitable for corrosive, viscous and interface applications.

Glass tube level gauges, with associated Gauge Cocks and protectors are also available for low pressure (17 bar) non-hazardous applications.

- > Pressures up to ANSI Class 1500 (250 bar).
- > Temperature range -196°C to +400°C.

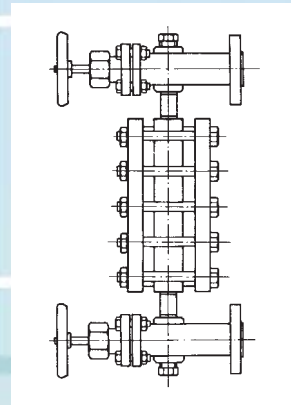

Standard TRANSPARENT

Type T50 PN 50 ANSI 300

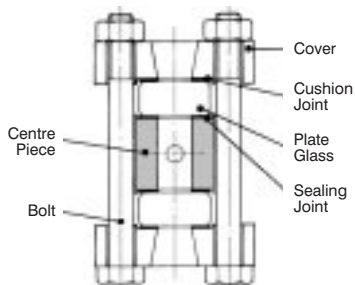

Weld-On

Type MWT

PN100
ANSI 600

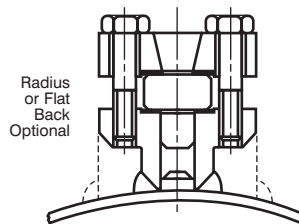

Transparent

Standard	Model	Rating
	T50	PN50, ANSI 300
	T100	PN100, ANSI 600
	T160	PN160, ANSI 900
	T250	PN250, ANSI 1500
Weld-On	MWT	PN100, ANSI 600

Materials	FS/H	M/H	M
Centre Piece	Carbon steel ASTM A105	Stainless steel AISI 316L	Stainless steel AISI 316L
Cover	Carbon steel ASTM A105	Carbon steel ASTM A105	Stainless steel AISI 316
Glass	Toughened (BS3463)	Toughened (BS3463)	Toughened (BS3463)
Sealing Joint	KLINGER jointing	KLINGER jointing	KLINGER jointing
Cushion Joint	KLINGER jointing	KLINGER jointing	KLINGER jointing
Bolt	Steel	Steel	Stainless steel
Nut	Steel	Steel	Stainless steel

NOTES

1. All gauges, with the exception of 'Weld-On' are suitable for use with RAV Valves and DG Gauge Cocks.
2. Refer to pages 4 for minimum centres, sight lengths and gauge configurations.
3. Ratings apply to standard and 'Weld-On' gauges in materials FS/H and M/H and large chamber gauges in all material grades.



Klinger originally invented the Reflex level gauge and the Group has since developed into a world market leader in liquid level monitoring equipment.

Today TC Klinger manufactures the most comprehensive range of Liquid level gauges suitable for the varied needs of the modern process plant. Used by most major process plant operators, engineering contractors and OEMs throughout the world, we can truly claim world leadership in this field. Our quality systems have been assessed to the requirements of BSEN ISO 9001.

We manufacture two types of shut-off fittings, gauge valves type RAV, rated up to ANSI Class 1500 and gauge cocks type DG rated ANSI Class 900. The RAV shut-off device is a metal seated valve with integral safety ball. Available in a variety of options it is suitable for most process requirements.

The DG gauge cock, with the replaceable packing sleeve and quick 90° operation provides an economical alternative for the simpler applications.

VALVES & COCKS

RAV Valves ANSI Class 900 and 1500

Inside Screwed ANSI 900/1500 (PN160-PN250)

Plain Nipple to Gauge-RAV946

- 946/1 Handwheel operation (ANSI 1500)
- 946/2 Weighted lever (ANSI 900)
- 946/3 Double ended lever (ANSI 900)
- 946/5 Quick closing handwheel (ANSI 900)

Union Nipple to Gauge – RAV947

- 947/1 Handwheel operation (ANSI 1500)
- 947/2 Weighted lever (ANSI 900)
- 947/3 Double ended lever (ANSI 900)
- 947/5 Quick closing handwheel (ANSI 900)

Approximate Weight 11kg/Set

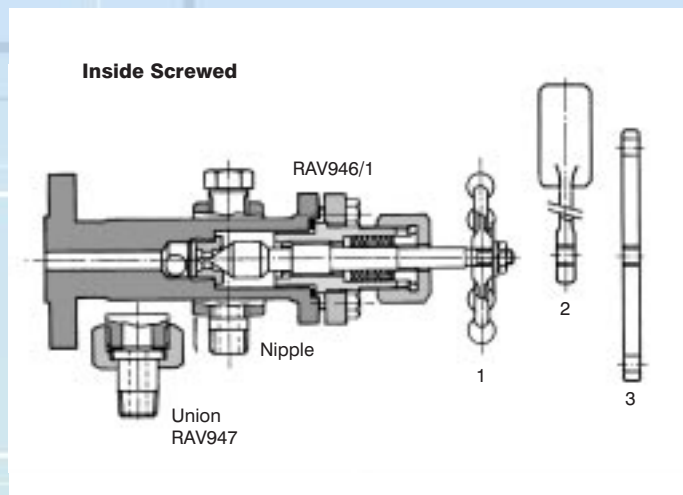

Outside Screwed ANSI 900/1500 (PN160-PN250)

Plain Nipple to Gauge-RAV956

- 956/1 Handwheel operation (ANSI 1500)
- 956/2 Weighted lever (ANSI 900)
- 956/3 Double ended lever (ANSI 900)
- 956/5 Quick closing handwheel (ANSI 900)

Union Nipple to Gauge – RAV957

- 957/1 Handwheel operation (ANSI 1500)
- 957/2 Weighted lever (ANSI 900)
- 957/3 Double ended lever (ANSI 900)
- 957/5 Quick closing handwheel (ANSI 900)

Approximate Weight 11kg/Set

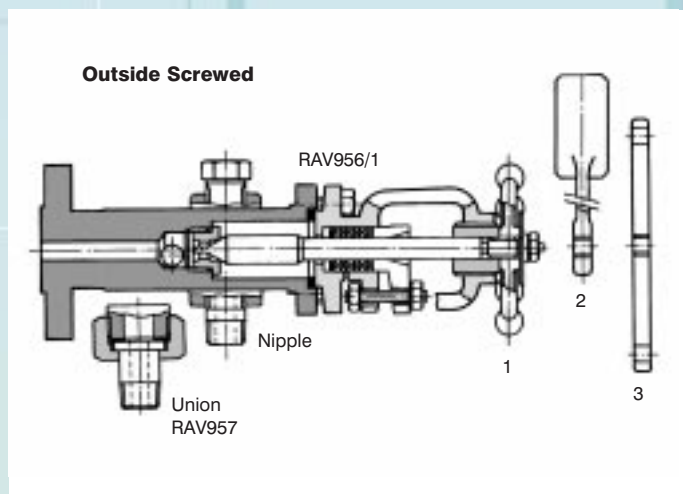

DG Gauge Cocks ANSI 900 (PN160)

- Quick 90° lever operation.
- Roddable.
- Replaceable packing sleeves (AB 18).
- Ball checks optional.

Approximate Weight 8kg/Set

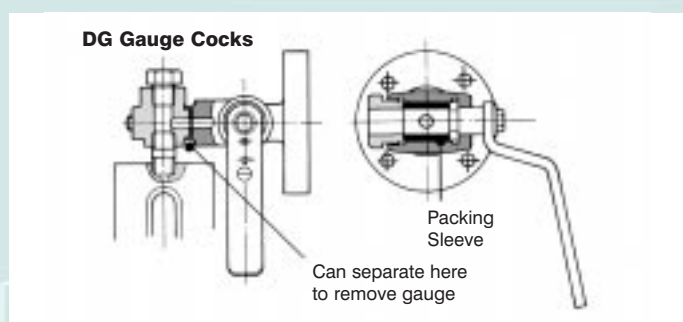

SELECTION DATA *Minimum 'M' Vessel Centres (mm)*

1. Select gauge type (See Page 2)

Standard, large chamber or weld-on. Reflex and Transparent can be used on most process applications but Transparent is recommended for:-

- Media which are corrosive to glass (eg. caustic alkalis, hydrofluoric acid, high pressure steam/water). In such cases Transparent Level Gauges must be protected by Mica or Kel-F shields (max.temp.120°C).
- Viscous media.
- Observation of colour or turbidity.
- Interface applications.
- Where lighting is inadequate and illuminators are required see following page.

Large Chamber Level Gauges are used only on applications where the medium boils or surges and 'Weld-On' Gauges for low pressure safe media applications.

2. Select the material (page 2)

3. Select the pressure rating required (page 2)

4. Select shut-off device (page 3)

5. Select the required configuration (Refer to tabulation)

Knowing the factors controlling the dimensions, (i.e. fixed vessel connections and/or fixed sight length, valve type RAV

or DG and connections screwed or union) select from the tabulations the nearest gauge combination observing the following points.

- Minimum vessel centres can be increased to suit the actual centres required.
- Maximum sight for any centre length is with side connected, offset inside.
- DG Cocks are usually supplied end connected.

Notes (see bottom of page)

Standard Gauges

(1-I to 9-IX)

- For 3/4" gauge connections dimensions as above.
- For 3/4" gauge connections add 14mm.
- For 3/4" screwed side or back add 34mm.
- T50-T100-T160-T250 with 1/2" back connections add 34mm.
- For 3/4" side or back connections add 34mm.

Note: 3/4" screwed connections not available on T250 and R250.

Large Chamber Gauges

(1-I to 6-IX)

- Overall length 'K' add 32mm.
- For flanged end connections or 1/2" end connected DG/RAVs add 32mm.
- For flanged/screwed side or back add 49mm.
- Refer to T & C for all configurations (ie. 3/4" connections).

Weld-On Gauges

(1-I to 4-IX)

- No valves supplied dimensions as S and K.

End Connected

1/2" End Connected

Side/back Connected

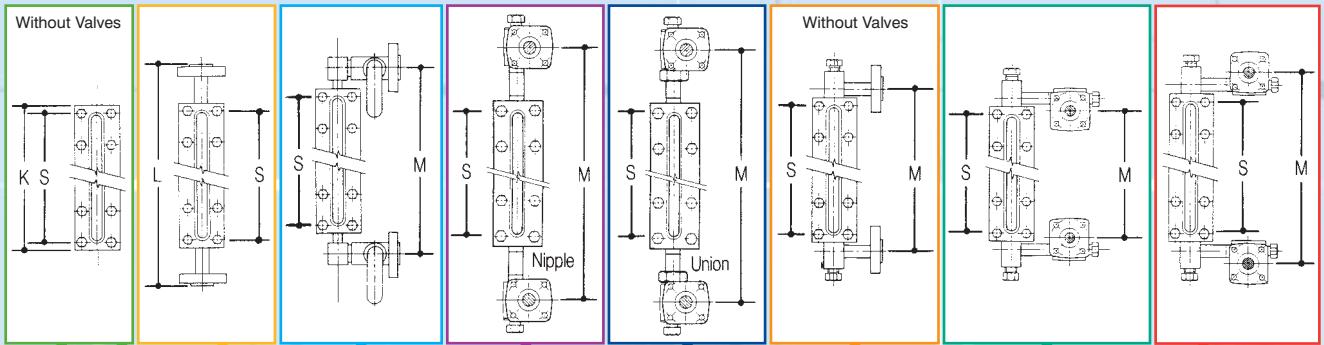

Gauge Size	Visible S	Flanged end K	Flanged end L	DG Cock	RAV Type 946, 956	RAV Type 947, 957	Flanged 1/2" Screwed Side or Back	1/2" Offset Inside All RAV Types	1/2" Offset Outside All RAV Types
1-I	93	128	278	190	225	265	154	114	194
1-II	118	153	303	215	250	290	179	139	219
1-III	143	178	328	240	275	315	204	164	244
1-IV	168	203	353	265	300	340	229	189	269
1-V	198	233	383	295	330	370	259	219	299
1-VI	228	263	413	325	360	400	289	249	329
1-VII	258	293	443	355	390	430	319	279	359
1-VIII	298	333	483	395	430	470	359	319	399
1-IX	318	353	503	415	450	490	379	339	419
2-IV	373	408	558	470	505	545	434	394	474
2-V	433	468	618	530	565	605	494	454	535
2-VI	493	528	678	590	625	665	554	513	594
2-VII	553	588	738	650	685	725	614	574	654
2-VIII	633	668	818	730	765	805	694	654	734
2-IX	673	708	858	770	805	845	734	694	774
3-VI	758	793	943	855	890	930	819	779	859
3-VII	848	883	1033	945	980	1020	909	869	949
3-VIII	968	1003	1153	1065	1100	1140	1029	989	1069
3-IX	1028	1063	1213	1125	1160	1200	1089	1049	1129
4-VII	1143	1178	1328	1240	1275	1315	1204	1164	1244
4-VIII	1303	1338	1488	1400	1435	1475	1364	1324	1404
4-IX	1383	1418	1568	1480	1515	1555	1444	1404	1484
5-VII	1438	1473	1623	1525	1570	1610	1499	1459	1539
5-VIII	1638	1673	1823	1735	1770	1810	1699	1659	1739
5-IX	1738	1773	1923	1835	1870	1910	1799	1759	1839
6-VIII	1973	2008	2158	2070	2105	2145	2034	1994	2074
6-IX	2093	2128	2278	2190	2225	2265	2154	2114	2194
7-VIII	2308	2343	2493	2405	2440	2480	2369	2329	2409
7-IX	2448	2483	2633	2545	2580	2620	2509	2469	2549
8-VIII	2643	2678	2828	2740	2775	2815	2704	2664	2744
8-IX	2803	2838	2988	2900	2935	2975	2864	2824	2904
9-VIII	2978	3013	3163	3075	3110	3150	3039	2999	3079
9-IX	3158	3193	3343	3255	3290	3330	3219	3179	3259

Notes on

Standard gauges - - - A B C D & E D & E

Notes on large Chamber & weld-on gauges F & J G G G G H I I

ACCESSORIES

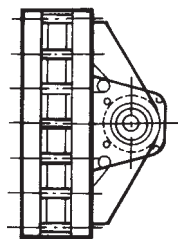

Fluorescent and L.E.D. Illuminators are available on request

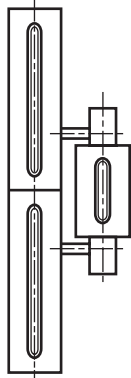

Uninterrupted sight where blind spots are not permitted

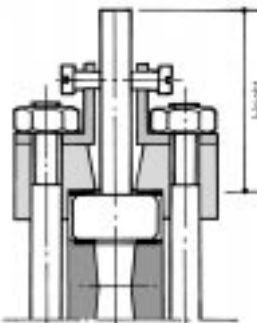

Non-frost blocks to permit viewing through frost build-up

PROCESS GAUGE WEIGHTS & BOLT TORQUES

To determine the weight of a multi-section gauge multiply the gauge size by the number of sections. The weights given are approximate only.

Gauge weights - kilogrammes

Gauge type	Gauge sizes									Cover Bolt Torques (lbf ft)
	I	II	III	IV	V	VI	VII	VIII	IX	
Reflex										
R100	2.5	3	3	4	4	5	5	6	7	36
R160	3	4	4	5	6	6	7	8	8	36
R250	4	5	6	7	8	9	10	11	12	55
MOR	3	4	4	5	5	6	6	7	8	11
UOR	5	6	7	7	8	9	10	11	12	22
MWR	3	4	4	5	6	6	7	8	9	36
Transparent										
T50	4	4	5	6	6	7	8	9	10	36
T100	5	6	7	8	9.5	10.5	11.5	13	14	36
T150	8	9	11	12	14	16	17	20	21	36
T250	15	16	17.3	18.5	20.5	22	23.5	26	28	58
MOT	5	5	6	7	8	8	9	10	11	11
UOT	7	8	9	10	11	13	14	16	16	22
MWT	3	4	4	5	6	6	7	8	9	36

DG valves 8kg per set (does not include weight of drain or vent valve).

RAV valves 11kg per set (does not include weight of drain or vent valve).

OTHER ACCESSORIES

Non-frosting blocks

(Max. temp. 110°C)

To prevent frost from forming on gauge glasses where the medium is at low temperature, a block of transparent acrylic resin may be affixed to any KLINGER level gauge. Recommended height of block for various temperature is as follows:-

Temperature of

Medium °C

0°C to -19°C

-20°C to -49°C

-50°C to -99°C

under -100°C

Height mm

38

75

150

200

Scales

Engraved scales, calibrated to customer requirements can be supplied for all TC KLINGER level gauges.

Specific gravity glass floats

Where the interface between two immiscible liquids is to be observed a special float can be provided in a transparent level gauge.

External centre piece heating

Heating tubes on outside of centre piece.

Internal heating

Heating tube in contact with medium.

LEVEL GAUGE ILLUMINATOR FOR HAZARDOUS AREAS

EEx rating according to type of bulb used

Type of E 27 bulb	EEx rating	Bulb ref.
15W incandescent (1)	EEx d Ilc T6	E27/15WI
60W incandescent (1)	EEx d Ilc T5	E27/60WI
75W incandescent (1)	EEx d Ilc T4	E27/75WI
15W fluocompact (2) 60W equivalent	EEx d Ilc T6	E27/15WF

Electrical Specification

Voltage: 110 - 230V AC (max 380V) - 50/60Hz, 6 to 48V DC

Cable entry: 3/4" NPT

IP rating: IP 65

EEx approval: ISSeP No. 98D. 103. 1283/970. 103.124

1 Illuminator body	6 Washer	11 Security pin
2 Diffuser (Plexiglas or glass)	7 Spring	12 Earth screw
3 Support bracket	8 Nut	13 Name plate
4 Nut	9 Bolt	
5 Gasket	10 Bonnet	

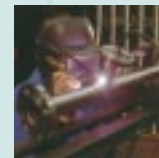
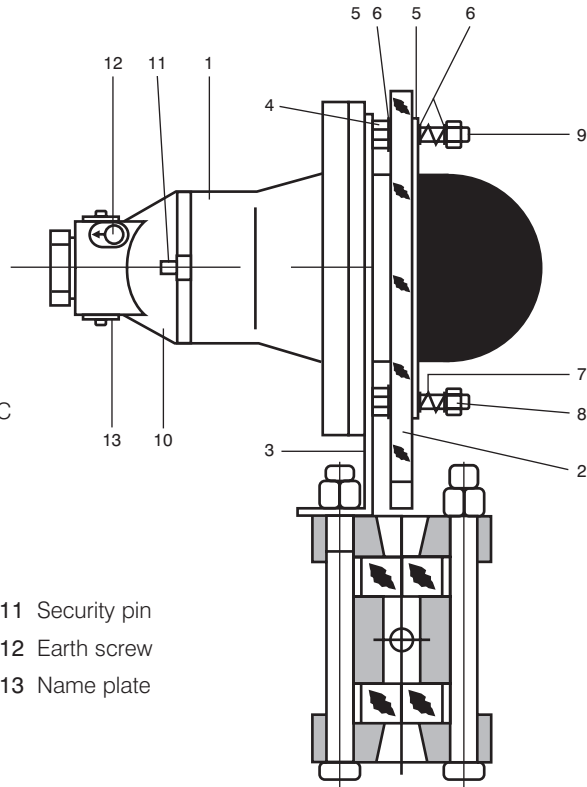

DISTRIBUTED BY

TC Fluid Control Ltd. Valves and Steam Division
 Broadgate, Broadway Business Park,
 Chadderton, Oldham, Lancashire OL9 9XA.
 Telephone: +44 (0)161 684 7488.
 Fax: +44 (0)161 684 7487.
 e-mail: energy@tc-fluidcontrol.com
 web site: www.tc-fluidcontrol.com

TC Fluid Control Ltd. Instrumentation Division
 Unit 49A, Victoria Industrial Park,
 Victoria Road, Dartford, Kent DA1 5AJ
 Telephone: +44 (0)1322 622400
 Fax: +44 (0)1322 285660
 e-mail: instruments@tc-fluidcontrol.com
 website: www.tc-fluidcontrol.com

